

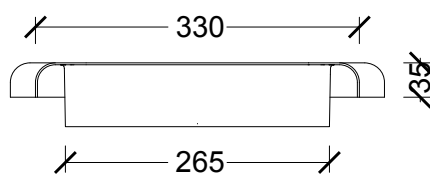

COPRIBORDO DISABILI

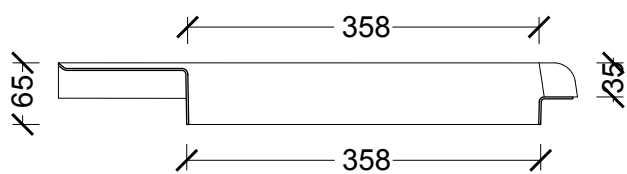
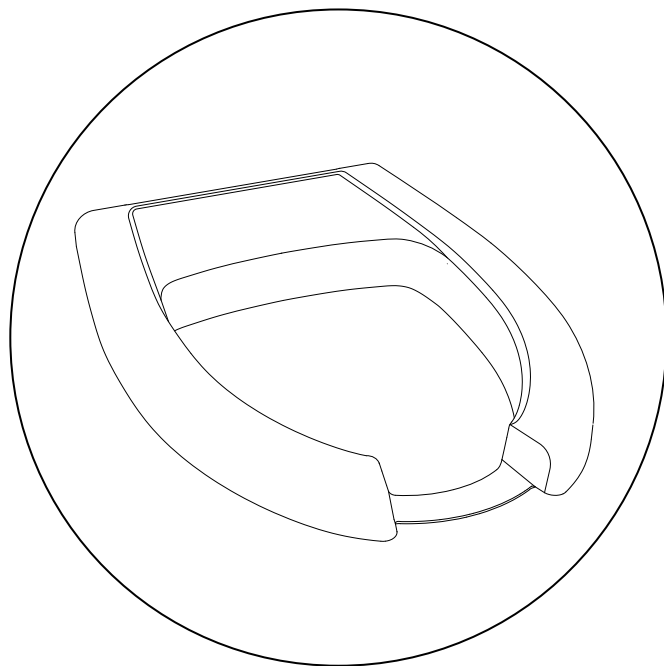
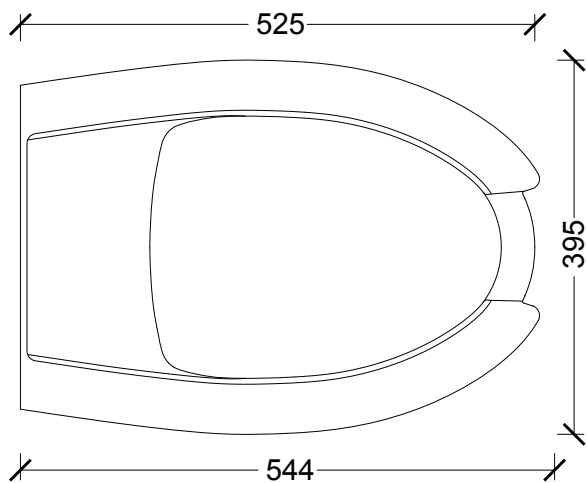

COD. 17
MAT. ABS
DATA 02/2018